

## La Loteria: A Mexican Bingo Game

Loteria arrived in Mexico the last half of the 18<sup>th</sup> century. It began as a Spanish colonial card game played for amusement by the social elite, but was eventually played by all social classes. Unlike bingo, loteria is played using a board filled with colorful illustrations and instead of numbers being drawn, cards with corresponding images are selected from a stack. There is yet another twist, the announcer does not simply say the name of the image, traditionally he recites a poem or phrase to hint at what the card depicts before revealing it by name.

Prior to the Spanish colonization of Mexico, the Aztecs of Mesoamerica played a similar game of chance called Patolli, which means beans in Nahuatl, the Aztec language. High wagers were placed on a Patolli game, sometimes resulting in the loss of home, freedom and family members. The main objective of the game is to move a marker across 52 squares on an X shaped game board. Beans, or patolli, with a painted white dot on one side would determine the passage of a player's markers.

Today, loteria is often played using beans as markers and can be utilized as an informal educational language tool. The Traditional Instrument Loteria, created by the Arizona State Museum, is an example of how this fun game can be a way to learn Spanish and Yaqui words, as well as an excellent introduction to Yaqui and Mexican culture.

### Hints and phrases for beginners:

\*As you learn more about these cultures try making up your own unique phrases for a more challenging and exciting game!

*Acordion:* Folded rectangle, companion of corridos.

*Tarola:* Drum roll please!

*Compositor de corridos:* A melodic messenger.

*Vihuela:* My sister needs six to sing, I only need five.

*Guitaron:* Big, bossy brother of Guitarra.

*Cantante de Mariachi:* The voice of the Jalisco horsemen and women.

*Trompeta:* A brass announcer.

*Va kupahe:* Liquid heart beat.

*Hirukia:* Legs of a wooden cricket.

*Tenevoim:* Abandoned caterpillar crib shaken back to life.

*Ayam:* Memory of the rain.

*Coosia:* Whisper to me and I will command the wind.

*Tampaleo:* Musical multi-tasker.

*Tambor:* Thunder barrel.

*Lavaleo:* Musician's bow and arrow.

*Apaleo:* A beauty admired for the long neck that frames her gold tresses.

*Koyolim:* Jingling stars bound around the waist.

*Sena'asom:* Tambourine on a stick.

*Sey wacheteme:* Half man, half deer, all spirit.



Cantante de Mariachi



Tarola  
(Snare Drum)

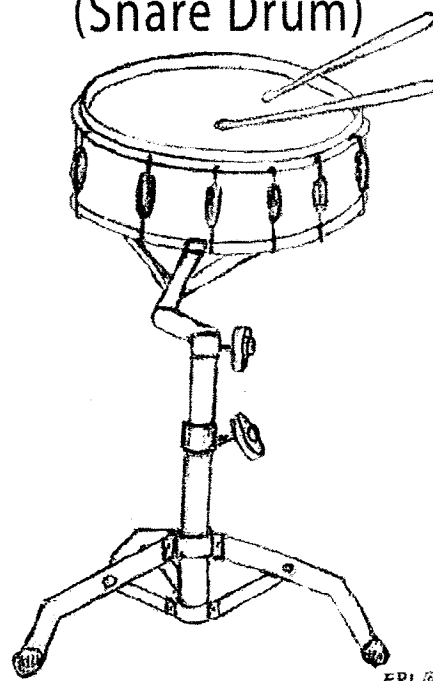

ERL®

Coosia (Flute)

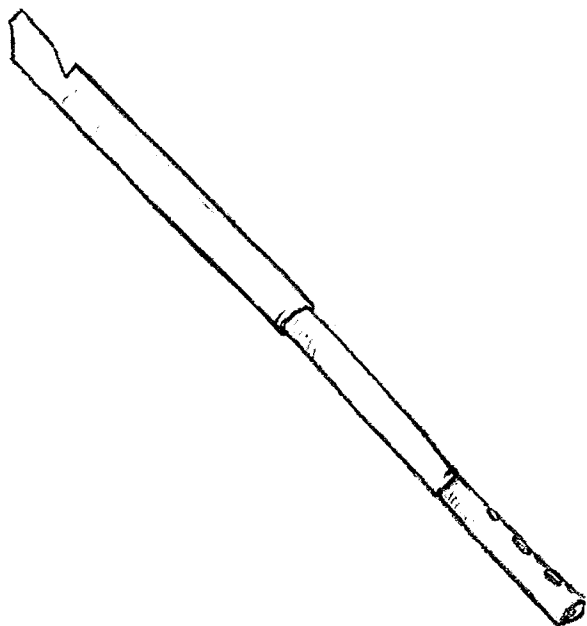

ERL®

Sena'asom  
(Tin Disc Rattle)

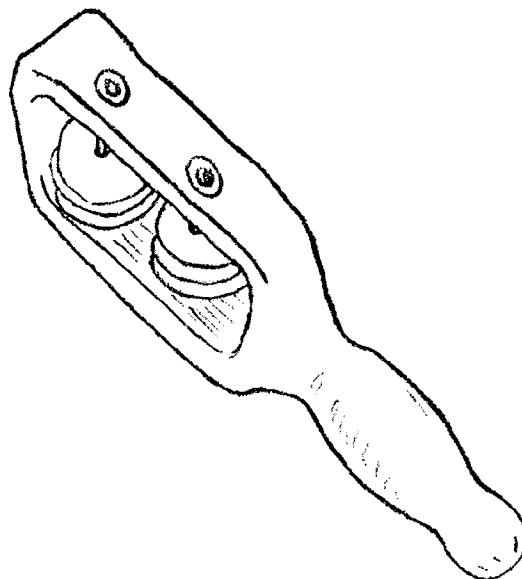

ERL®

Guitarra  
(Guitar)

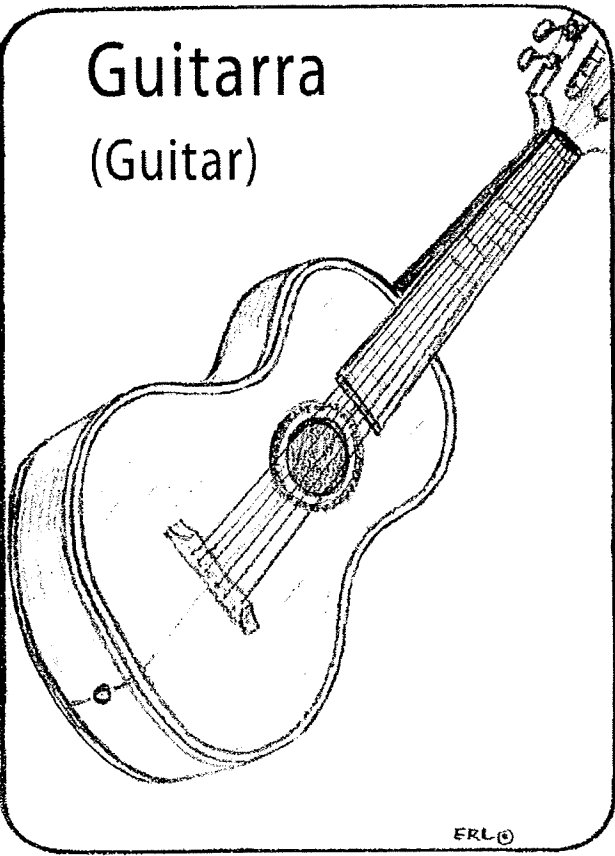

ERL ©

Arpa (Harp)

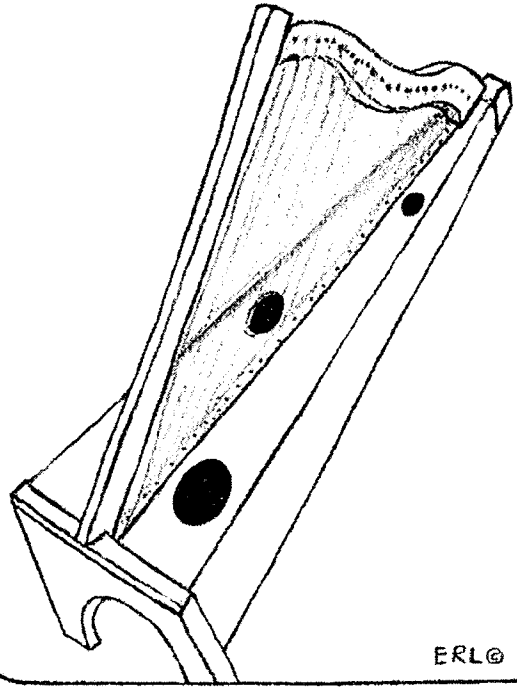

ERL ©

Hirukia  
(Rasp Sticks)

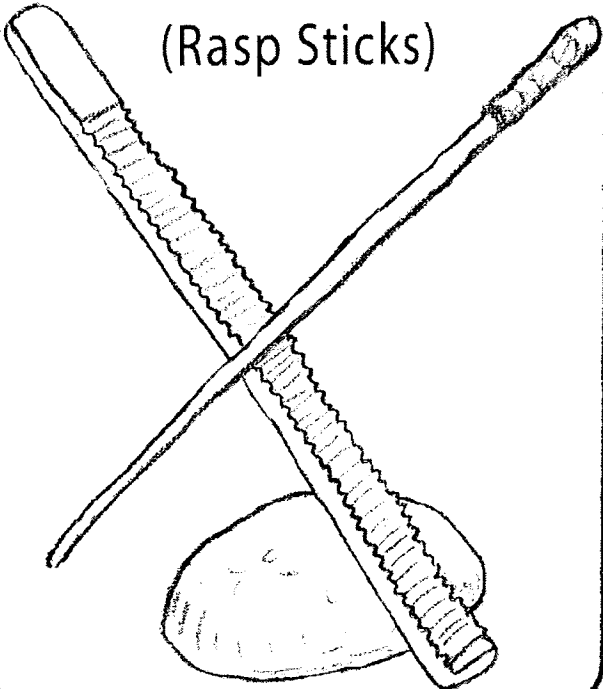

ERL ©

Ayam  
(Gourd Rattle)

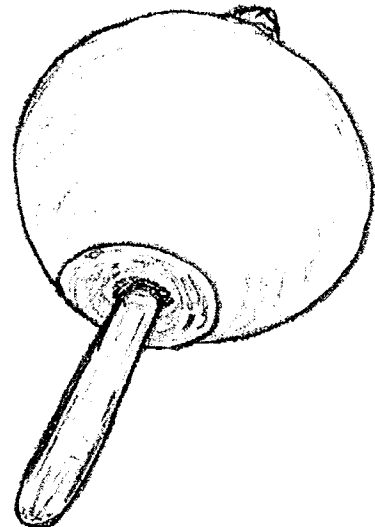

ERL ©

Sey Wachetame  
(Deer Dancer)



Tambor (Drum)

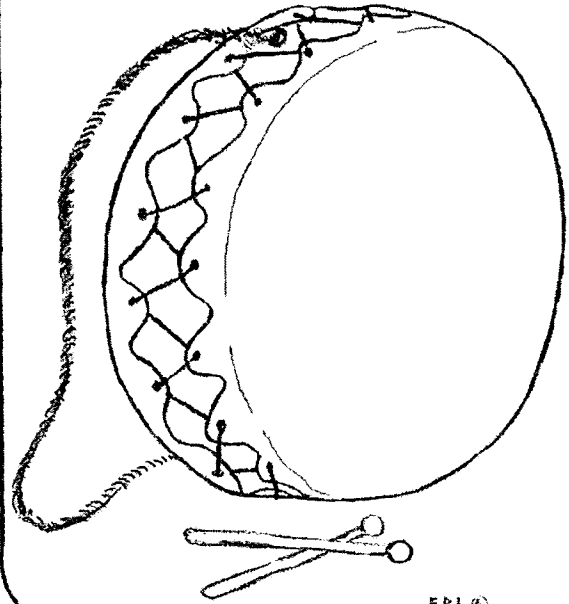

Vihuela  
(Five String Guitar)



Tampaleo  
(Flute and Drum Player)

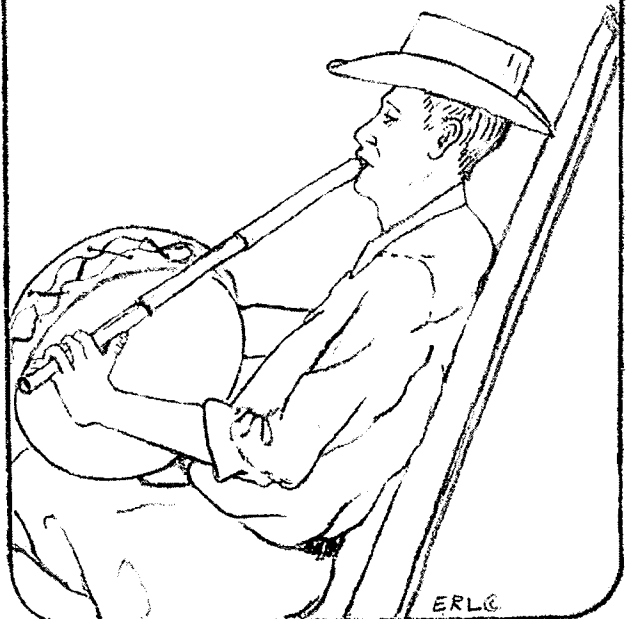

Trompeta  
(Trumpet)

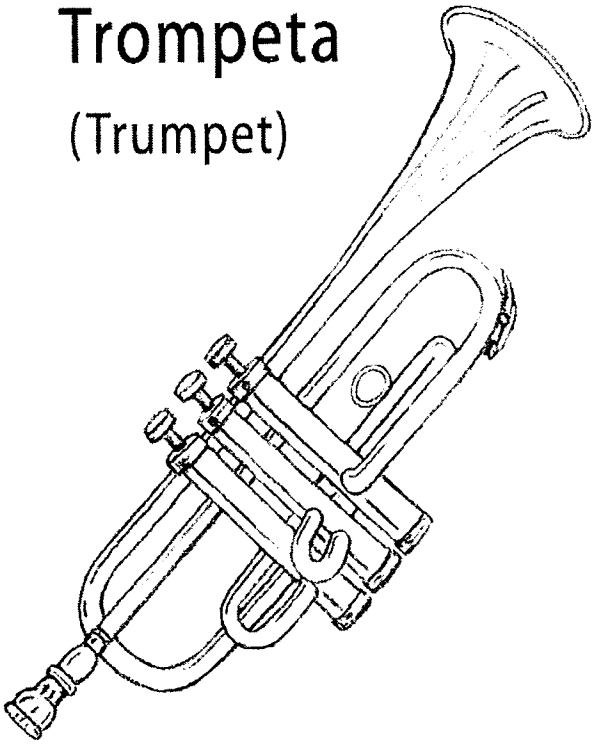

ERLO

Violin

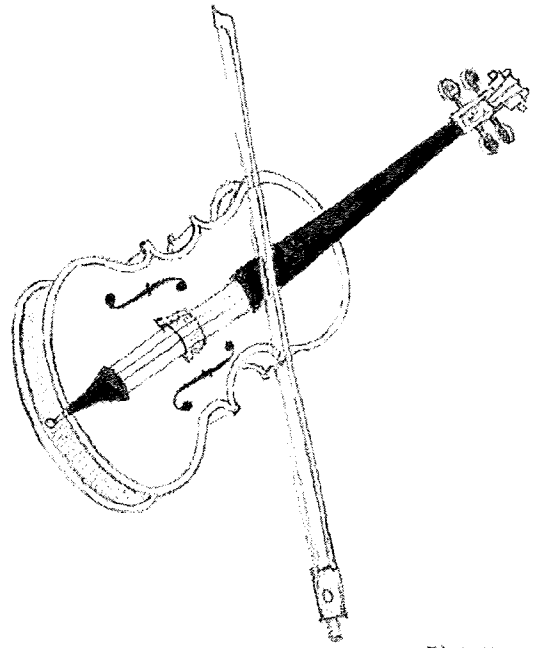

ERLO

Va Kuvahe  
(Water Drum)

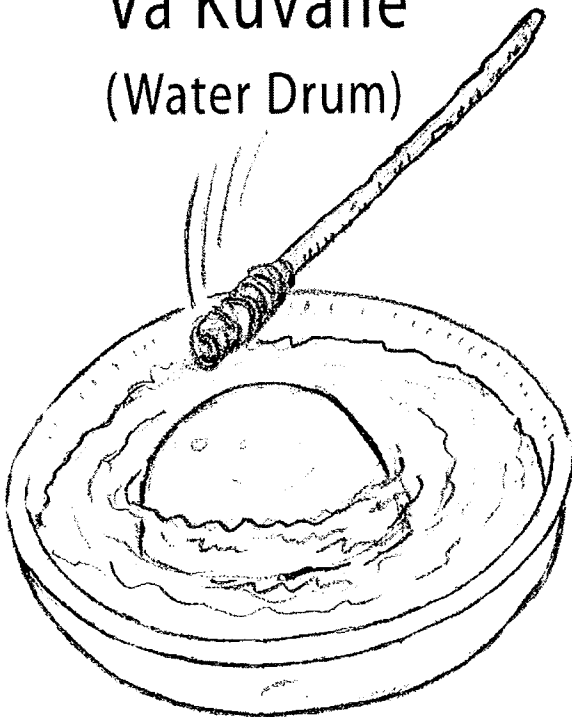

ERLO

Pahkola Mascara  
(Pahkola Mask)



ERLO

Acordion  
(Accordion)

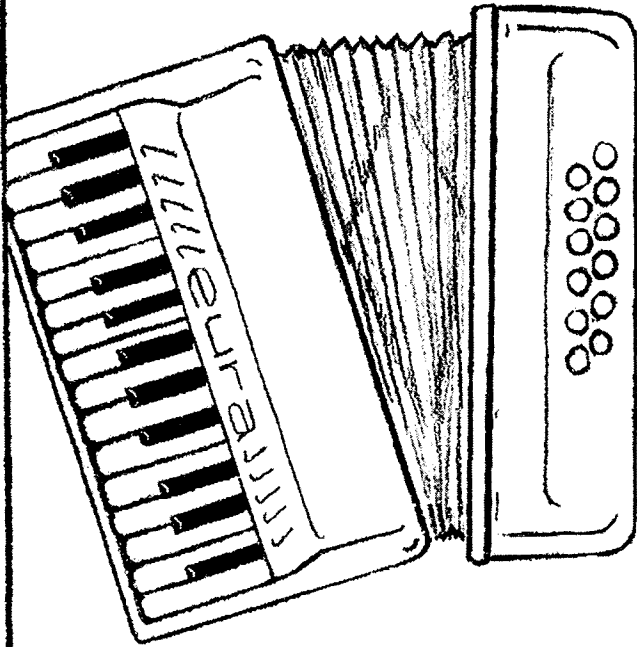

ERL®

Guitarrón  
(Bass Guitar)

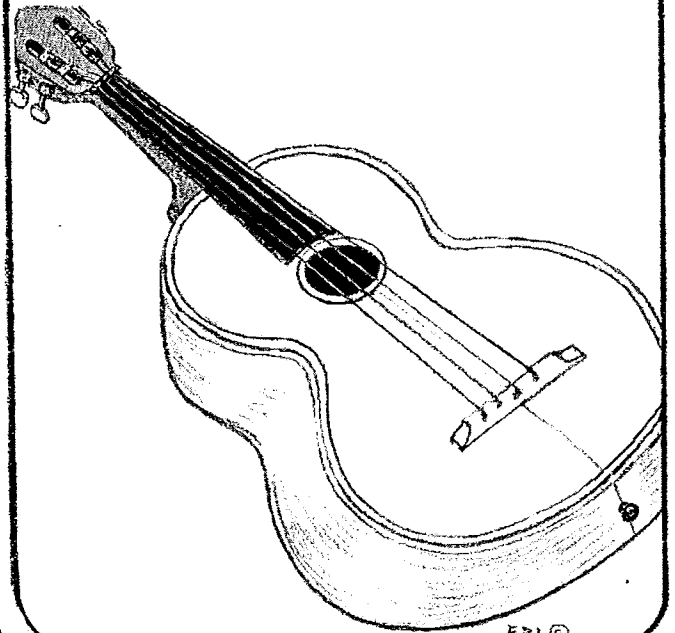

ERL®

Koyolim

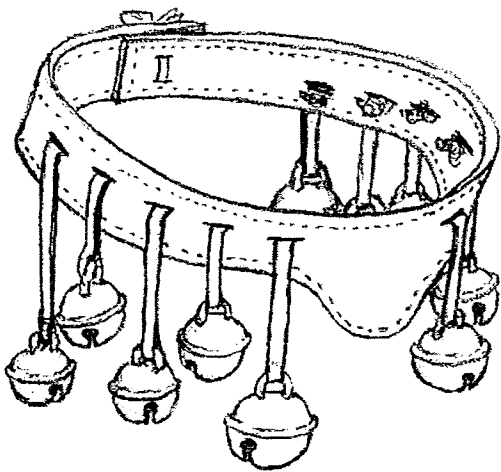

(Belt with Brass Bells)

ERL®

Tenevoim  
(Cocoon Leg Rattles)



ERL®

Guitarrón  
(Bass Guitar)

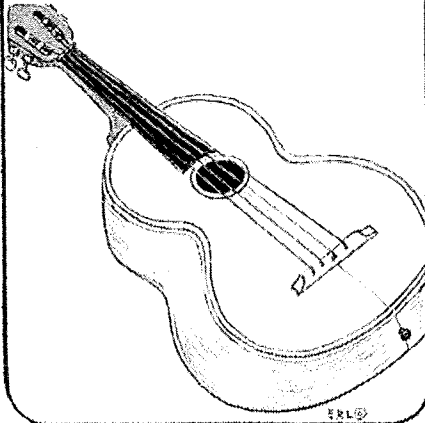

Koyolim

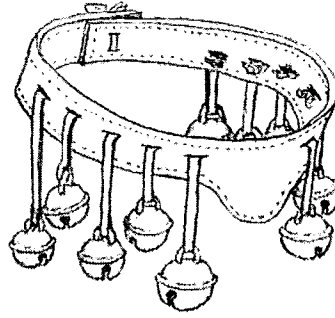

(Belt with Brass Bells)

Tambor (Drum)

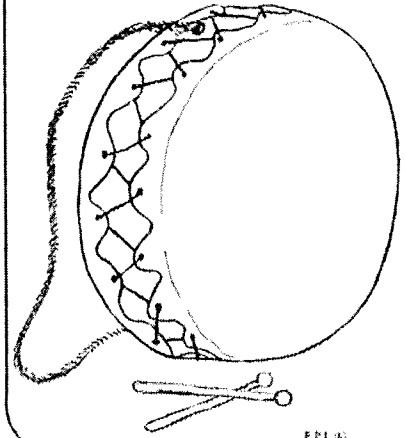

Tampaleo  
(Flute and Drum Player)



Arpa (Harp)

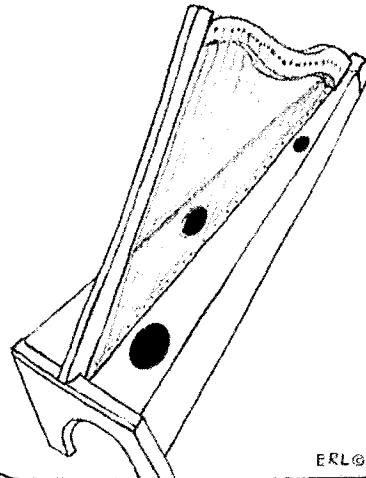

Hirukia

(Rasp Sticks)

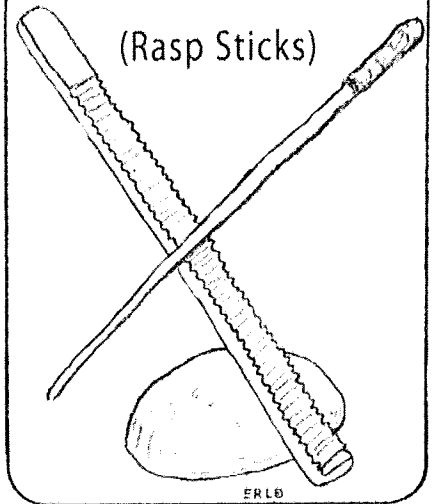

Tarola  
(Snare Drum)

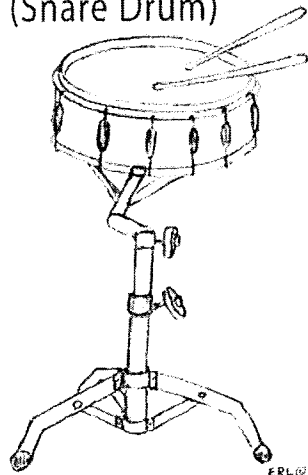

Ayam  
(Gourd Rattle)

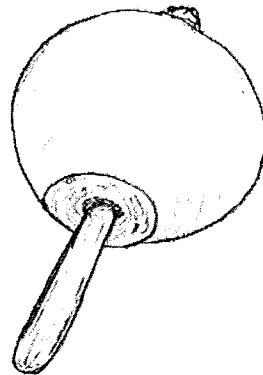

Tenevoim  
(Cocoon Leg Rattles)



Acordion  
(Accordion)

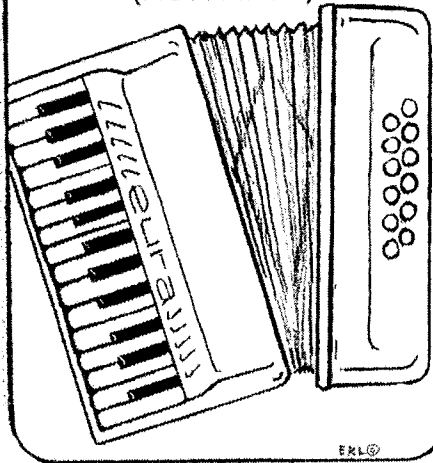

ERL®

Tambor (Drum)

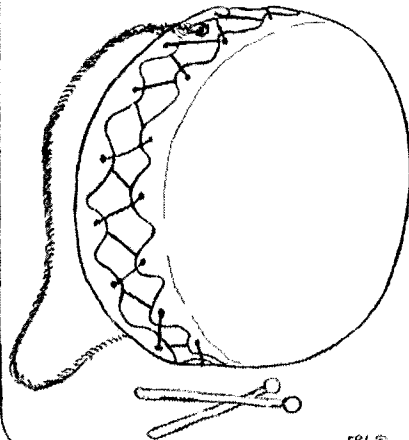

ERL®

Koyolim

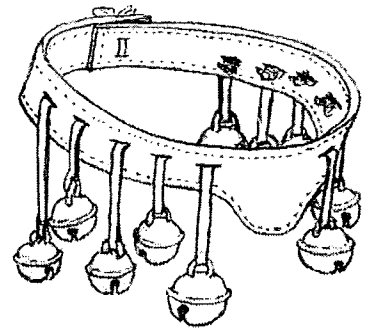

(Belt with Brass Bells)

ERL®

Arpa (Harp)

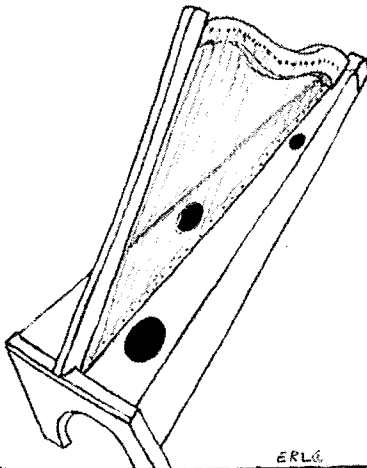

ERL®

Guitarrón  
(Bass Guitar)



ERL®

Trompeta  
(Trumpet)

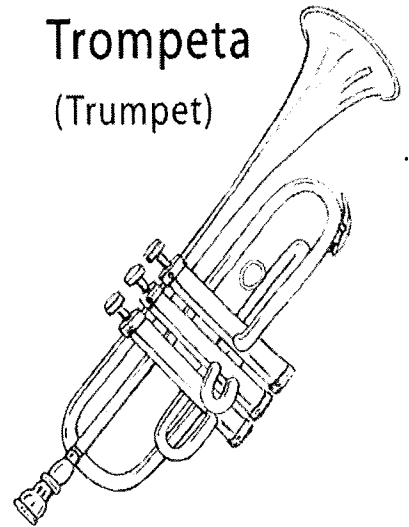

ERL®

Sey Wachetame  
(Deer Dancer)



ERL®

Hirukia  
(Rasp Sticks)

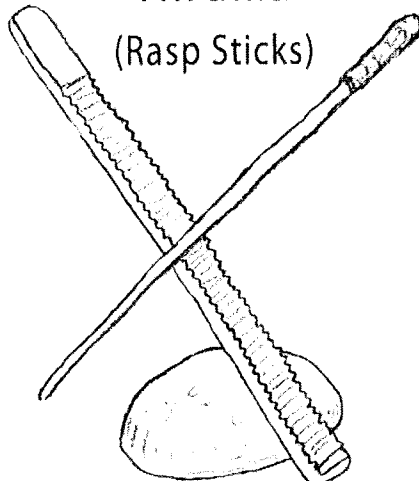

ERL®

Ayam  
(Gourd Rattle)

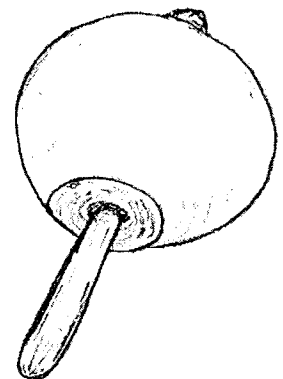

ERL®





Tampaleo  
(Flute and Drum Player)



Sena'asom  
(Tin Disc Rattle)

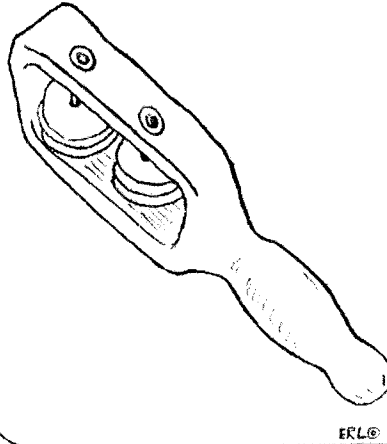

Tarola  
(Snare Drum)

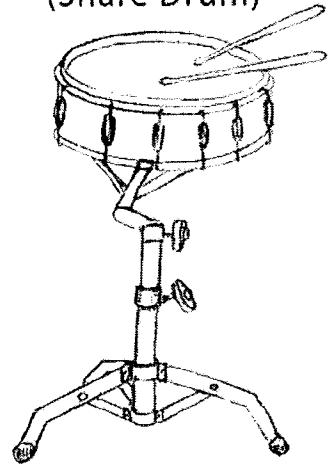

Coosia (Flute)

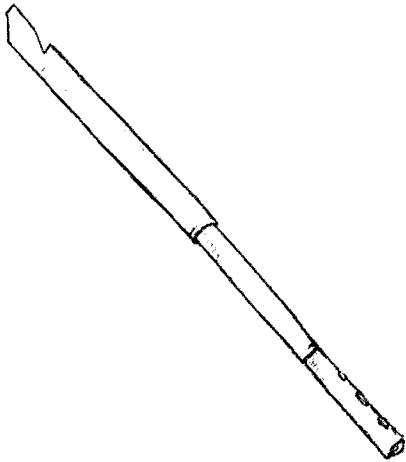

Vihuela  
(Five String Guitar)

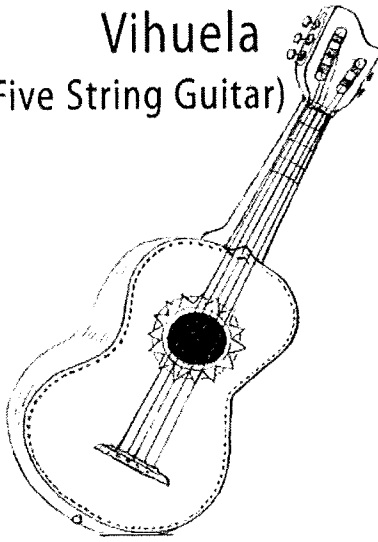

Tenevoim  
(Cocoon Leg Rattles)



Arpa (Harp)

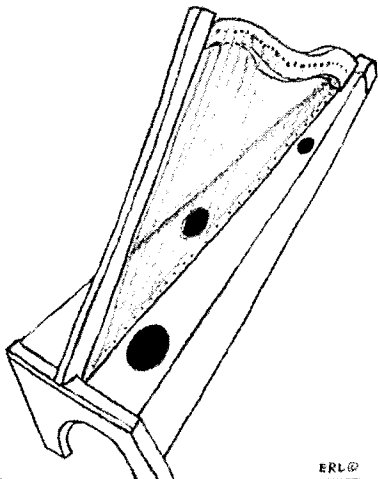

Sey Wachetame  
(Deer Dancer)

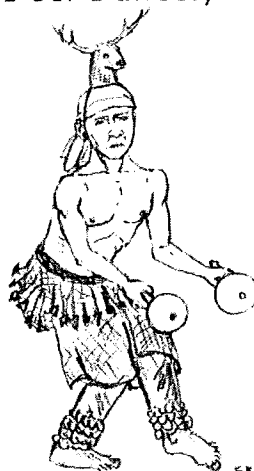

Hirukia  
(Rasp Sticks)

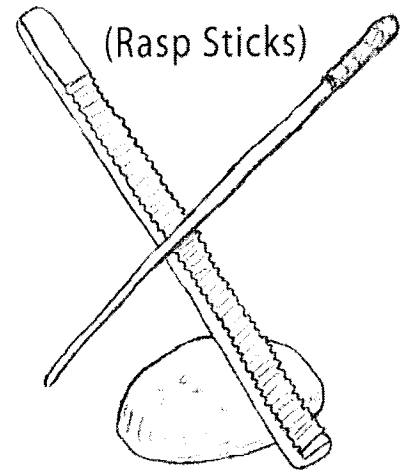

Guitarrón  
(Bass Guitar)

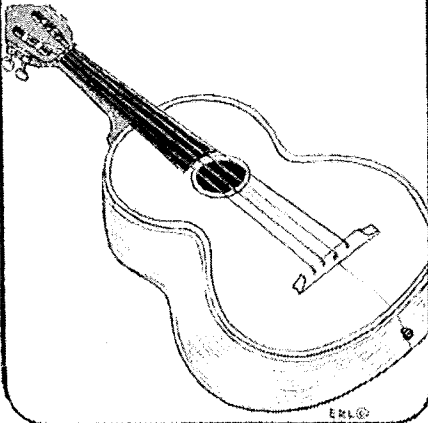

Koyolim

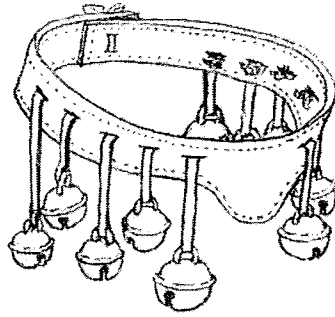

(Belt with Brass Bells)

Tambor (Drum)

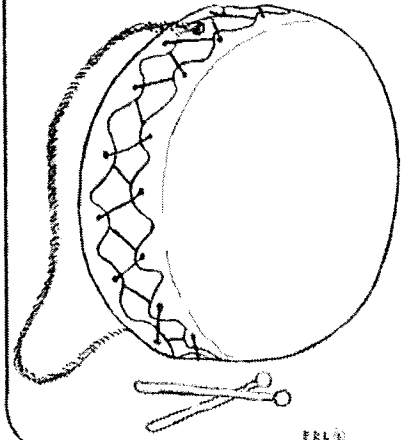

Tampaleo  
(Flute and Drum Player)

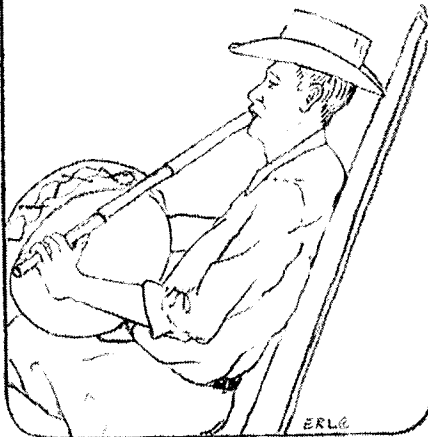

Arpa (Harp)

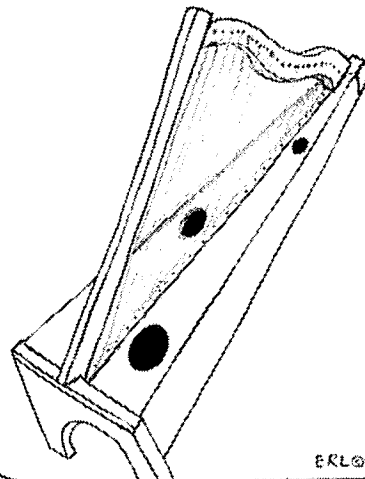

Hirukia  
(Rasp Sticks)

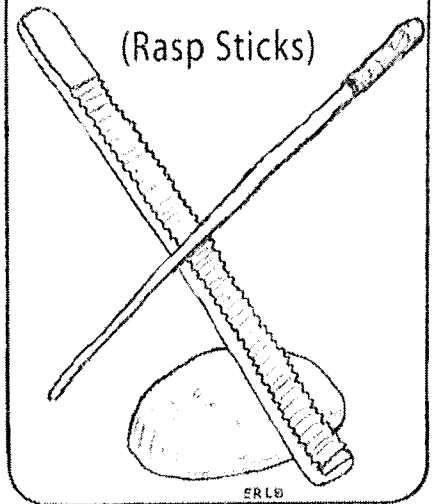

Tarola  
(Snare Drum)

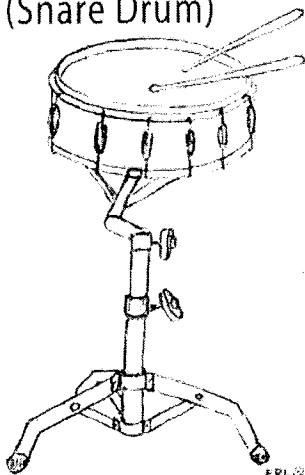

Ayam  
(Gourd Rattle)

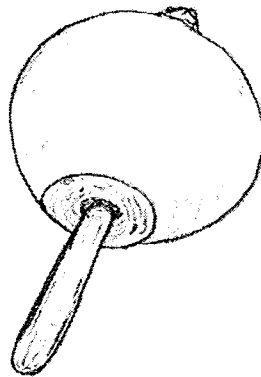

Tenevoim  
(Cocoon Leg Rattles)



Violin

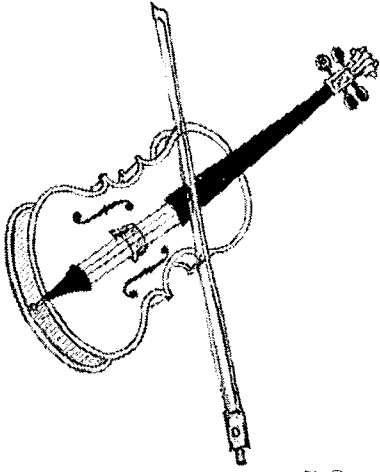

ERL®

Pahkola Mascara  
(Pahkola Mask)



ERL®

Va Kuvaha  
(Water Drum)

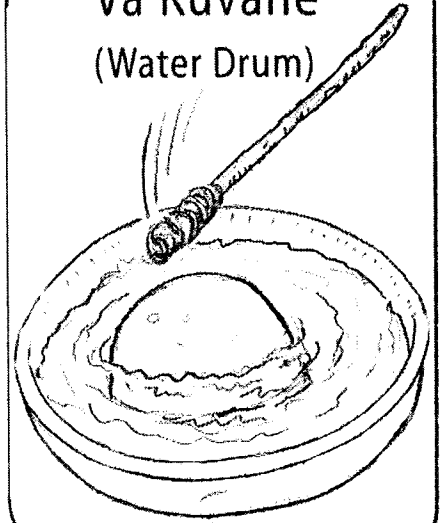

ERL®

Hirukia  
(Rasp Sticks)

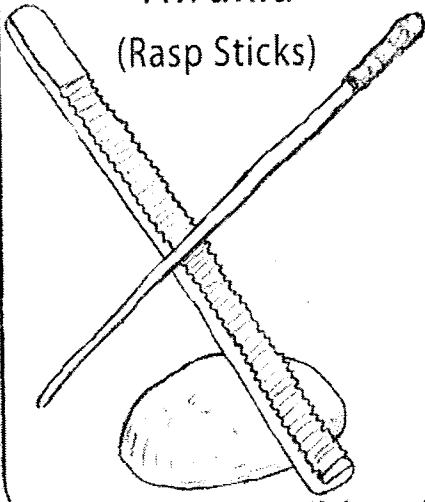

ERL®

Cantante de Mariachi



Guitarra  
(Guitar)

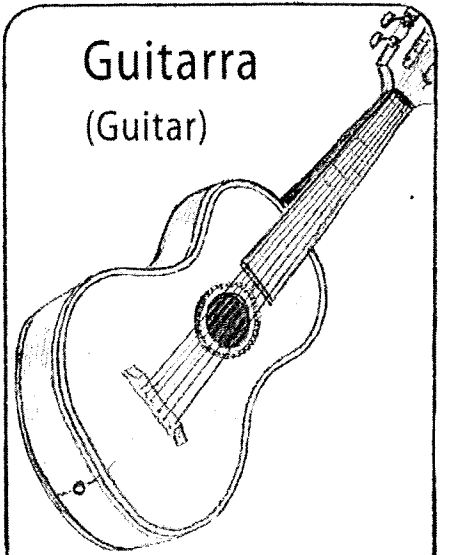

ERL®

Sena'asom  
(Tin Disc Rattle)

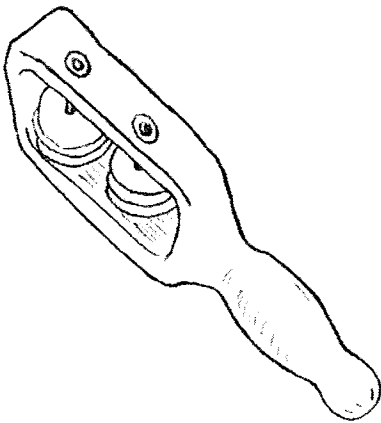

ERL®

Ayam  
(Gourd Rattle)

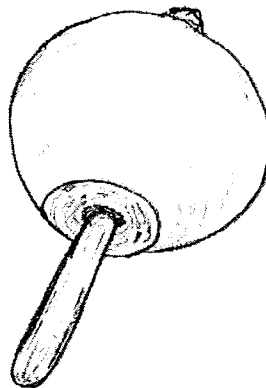

ERL®

Arpa (Harp)

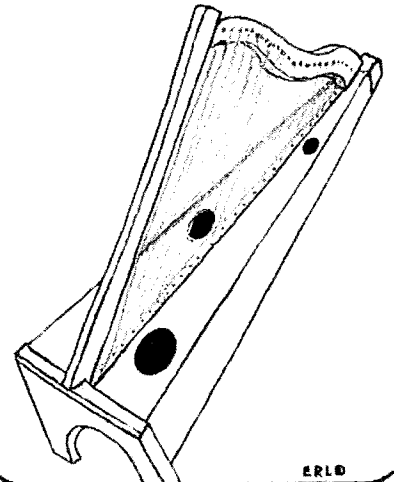

ERL®

Violin

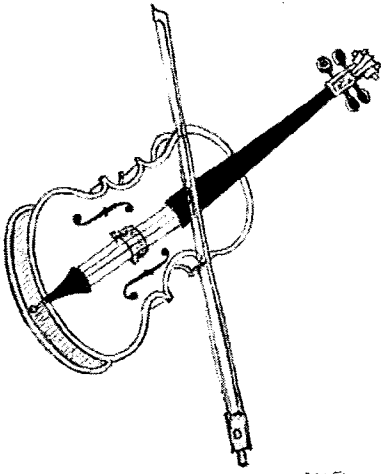

ERL®

Sey Wachetame  
(Deer Dancer)

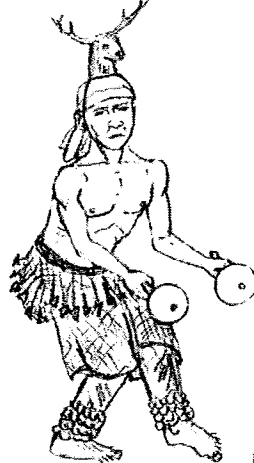

ERL®

Va Kuvahe  
(Water Drum)

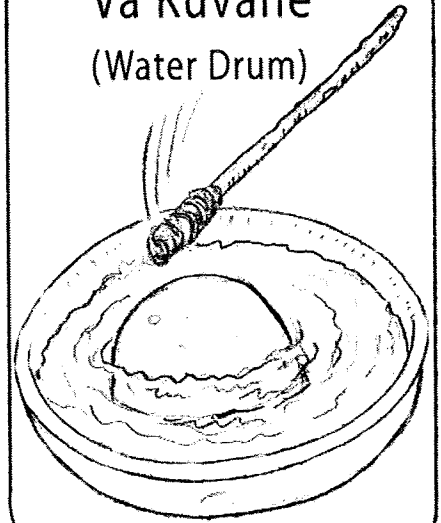

ERL®

Hirukia  
(Rasp Sticks)

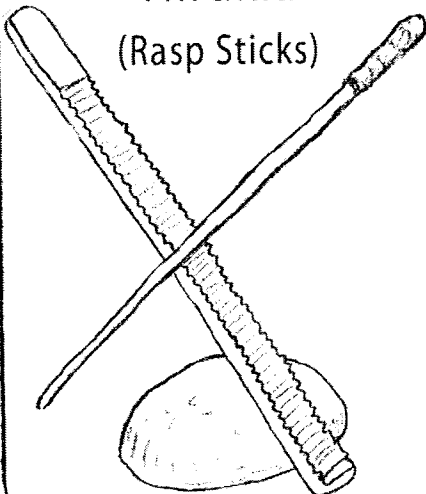

ERL®

Trompeta  
(Trumpet)

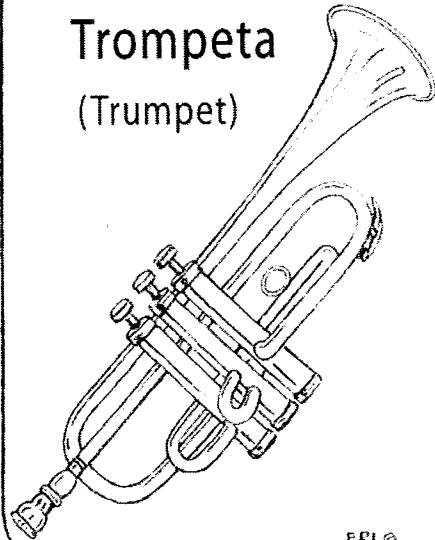

ERL®

Guitarra  
(Guitar)

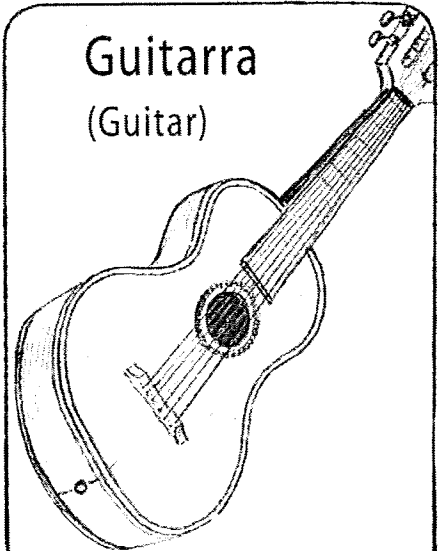

ERL®

Sena'asom  
(Tin Disc Rattle)

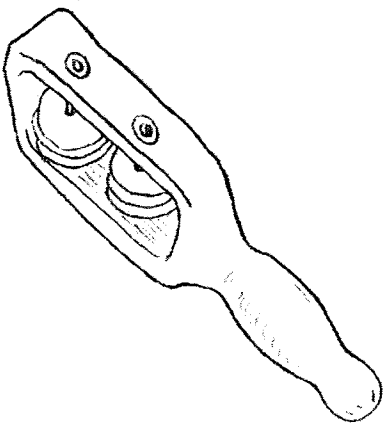

ERL®

Ayam  
(Gourd Rattle)

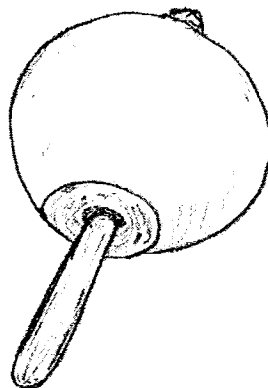

ERL®

Arpa (Harp)

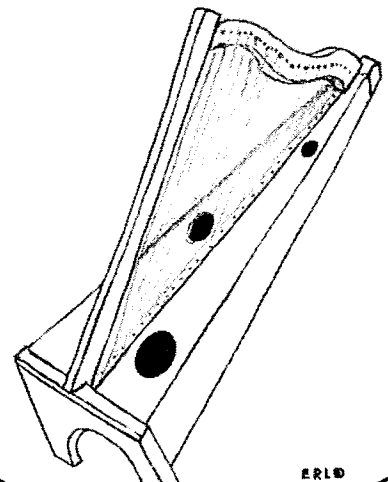

ERL®

Guitarrón  
(Bass Guitar)

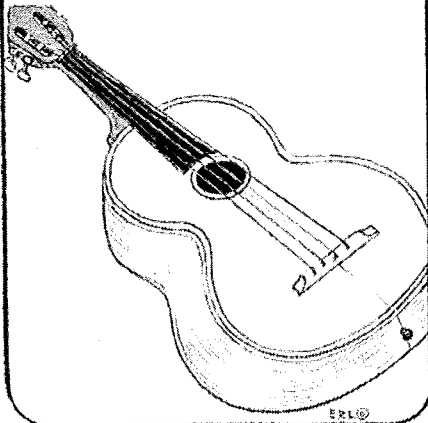

ERL®

Koyolim

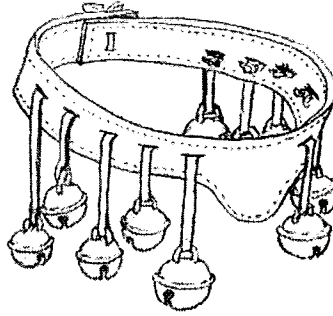

(Belt with Brass Bells)

ERL®

Tambor (Drum)

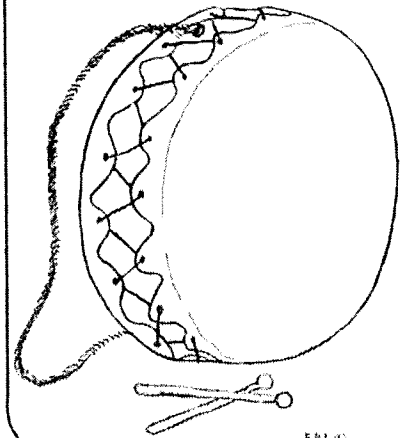

ERL®

Tampaleo  
(Flute and Drum Player)



ERL®

Arpa (Harp)

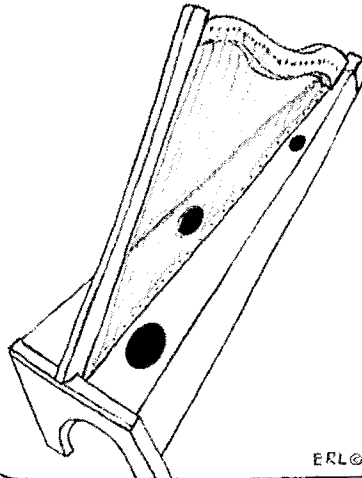

ERL®

Hirukia  
(Rasp Sticks)

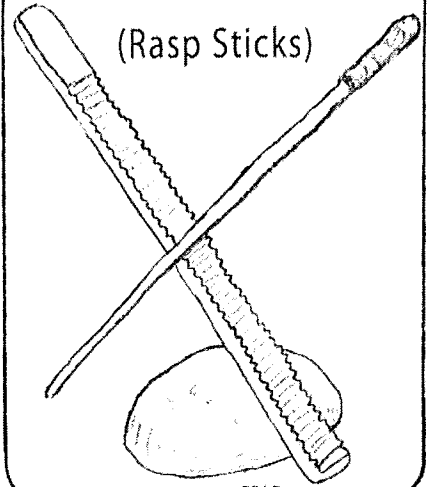

ERL®

Tarola  
(Snare Drum)

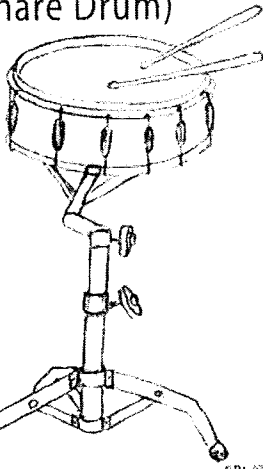

ERL®

Ayam  
(Gourd Rattle)

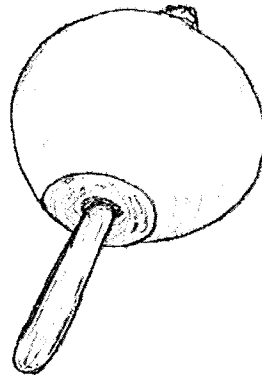

ERL®

Tenevoim  
(Cocoon Leg Rattles)



ERL®

Coosia (Flute)

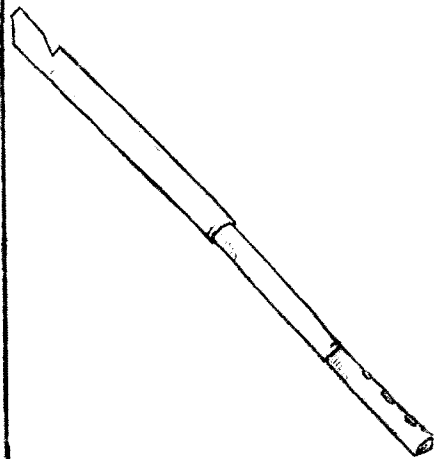

ERL©

Vihuela  
(Five String Guitar)

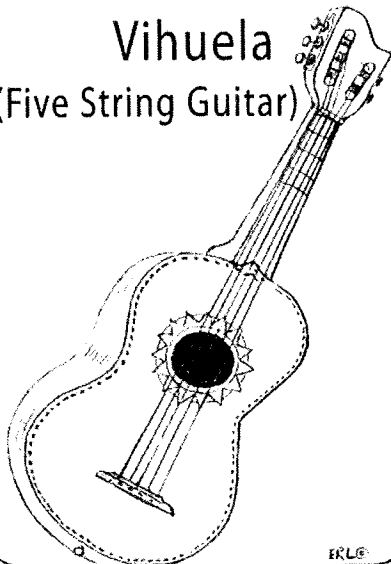

ERL©

Tampaleo  
(Flute and Drum Player)



ERL©

Guitarrón  
(Bass Guitar)



ERL©

Tarola  
(Snare Drum)

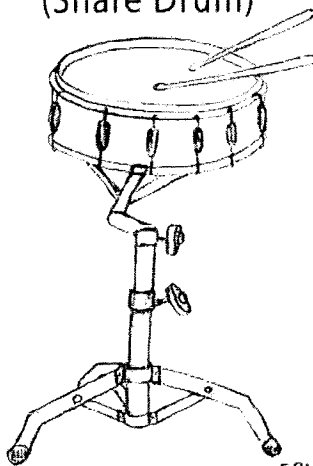

ERL©

Tambor (Drum)

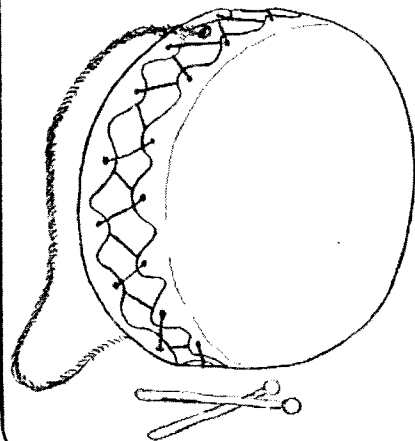

ERL©

Sena'asom  
(Tin Disc Rattle)

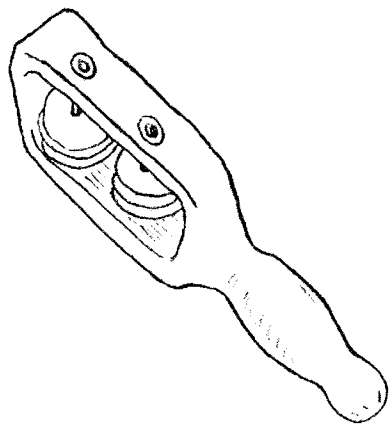

ERL©

Tenevoim  
(Cocoon Leg Rattles)



ERL©

Arpa (Harp)

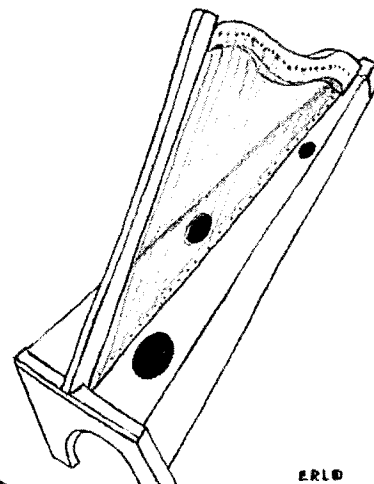

ERL©



Coosia (Flute)

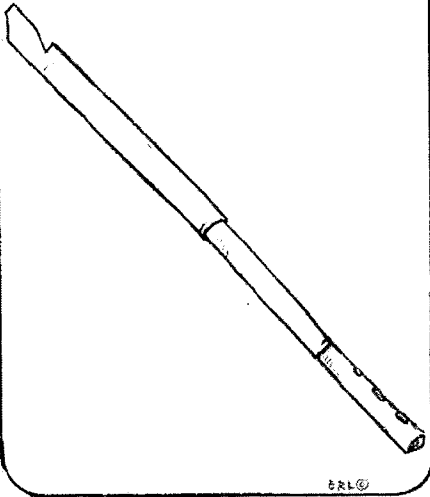

ERL®

Vihuela  
(Five String Guitar)



ERL®

Tampaleo  
(Flute and Drum Player)

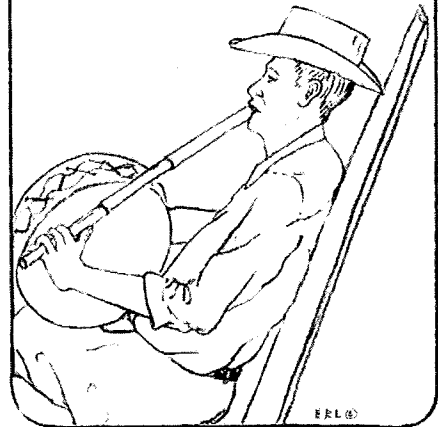

ERL®

Guitarrón  
(Bass Guitar)



ERL®

Tarola  
(Snare Drum)

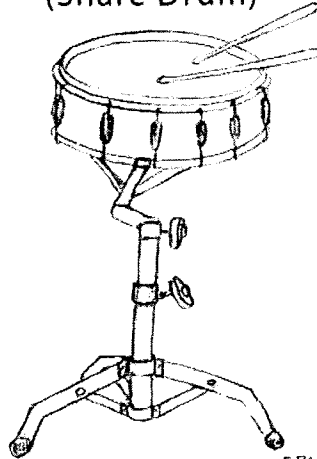

ERL®

Tambor (Drum)

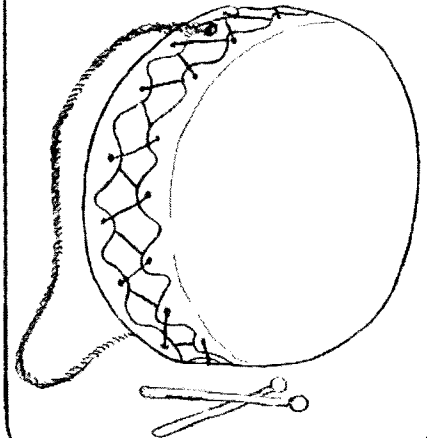

ERL®

Violin

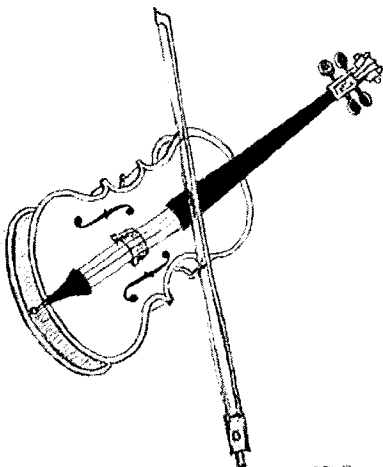

ERL®

Tenevoim  
(Cocoon Leg Rattles)



ERL®

Guitarra  
(Guitar)

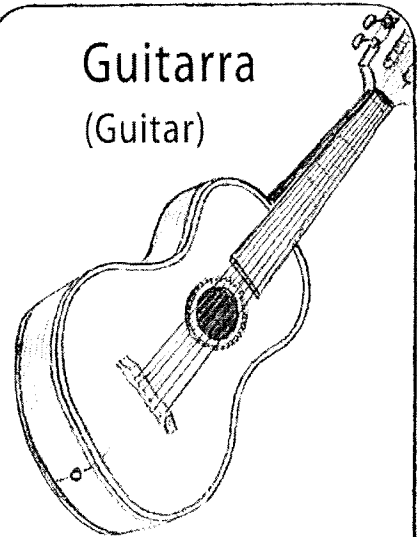

ERL®

Pahkola Mascara  
(Pahkola Mask)



Vihuela  
(Five String Guitar)

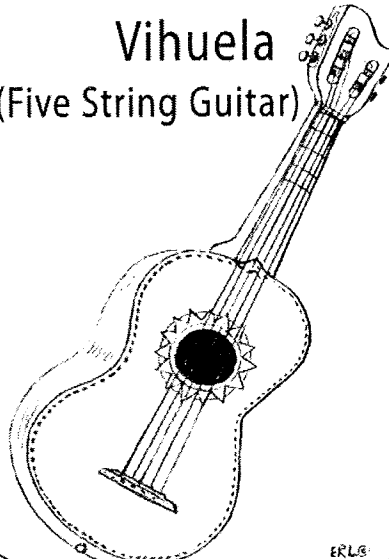

Tampaleo  
(Flute and Drum Player)

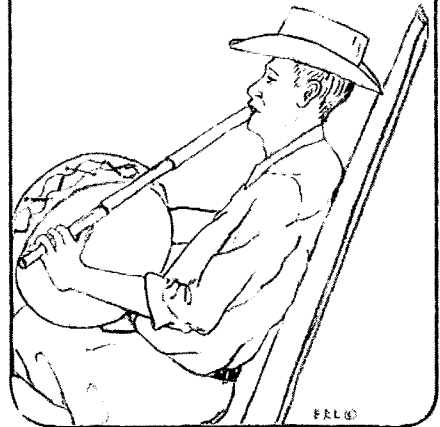

Guitarrón  
(Bass Guitar)



Va Kuvahé  
(Water Drum)

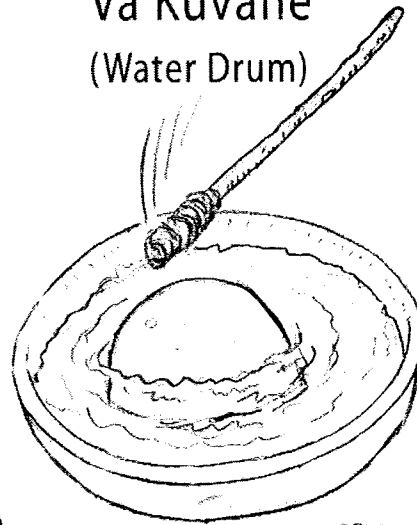

Tambor (Drum)

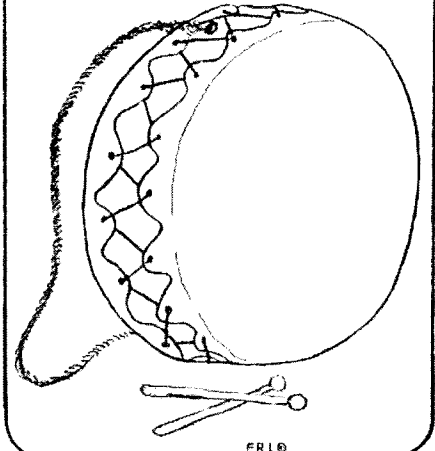

Violin

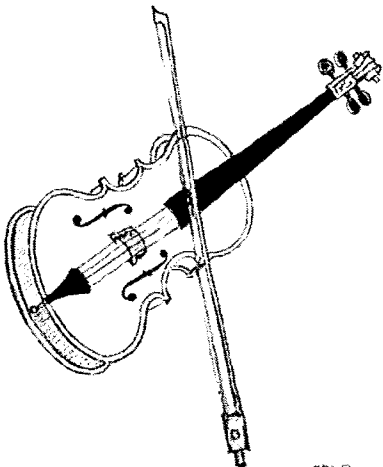

Tenevoim  
(Cocoon Leg Rattles)



Guitarra  
(Guitar)

